

HANNA LITERATURE

Hanna publishes a wide range of catalogs and handbooks for an equally wide range of applications. The reference literature currently covers areas such as:

- Water Treatment
- Process
- Swimming Pools
- Agriculture
- Food
- Laboratory
- Thermometry

and many others. New reference material is constantly being added to the library.

For these and other catalogs, handbooks and leaflets, contact your dealer or the Hanna Customer Service Center nearest to you. To find the Hanna Office in your vicinity, check our home page at www.hannainst.com.



<http://www.hannainst.com>

Instruction Manual

pH 210 pH 211
pH 212 pH 213

**Microprocessor-based
Bench pH/mV/°C Meters**

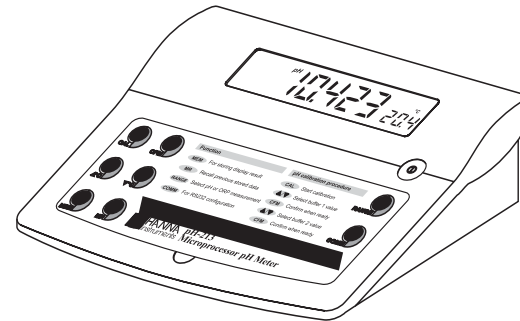

MANPH213R2 02/00

HANNA
instruments
Manufacturers since 1978

CE
These Instruments are in
Compliance with the CE Directives

Dear Customer,
 Thank you for choosing a Hanna Product. Please read this instruction manual carefully before using the instrument.
 This manual will provide you with the necessary information for a correct use of the instrument, as well as a precise idea of its versatility.
 If you need more technical information, do not hesitate to e-mail us at tech@hannainst.com.
 These instruments are in compliance with **CE** directives.

TABLE OF CONTENTS

PRELIMINARY EXAMINATION	3
GENERAL DESCRIPTION	3
FUNCTIONAL DESCRIPTION pH 210 AND pH 211	4
SPECIFICATIONS pH 210 AND pH 211	5
FUNCTIONAL DESCRIPTION pH 212 AND pH 213	6
SPECIFICATIONS pH 212 AND pH 213	7
OPERATIONAL GUIDE	8
pH CALIBRATION	11
TEMPERATURE CALIBRATION (pH 212 AND pH 213 ONLY)	14
mV CALIBRATION (pH 213 ONLY)	15
INTERFACE WITH PC (pH 212 AND pH 213 ONLY)	16
pH VALUES AT VARIOUS TEMPERATURES	18
ELECTRODE CONDITIONING & MAINTENANCE	19
TEMPERATURE CORRELATION FOR pH SENSITIVE GLASS	22
TROUBLESHOOTING GUIDE	23
ACCESSORIES	24
WARRANTY	30
CE DECLARATION OF CONFORMITY	31



CE DECLARATION OF CONFORMITY





DECLARATION OF CONFORMITY

We

Hanna Instruments Italia Srl
 via E. Fermi, 10
 35030 Sarmeola di Rubano - PD
 ITALY

herewith certify that the bench-top microprocessor pH meters:

pH 210 pH 211 pH 212 pH 213

have been tested and found to be in compliance with the following regulations:

IEC 801-2	Electrostatic Discharge
IEC 801-3	RF Radiated
IEC 801-4	Fast Transient
EN 55022	Radiated, Class B
EN 61010-1	User Safety Requirement

Date of Issue: 8-4-1999

 D. Volpato - Engineering Manager
 On behalf of
 Hanna Instruments S.r.l.

Recommendations for Users

Before using this product, make sure that it is entirely suitable for the environment in which it is used.

Operation of this instrument in residential areas could cause unacceptable interferences to radio and TV equipment, requiring the operator to take all necessary steps to correct interferences.

The glass bulb at the end of the pH electrode is sensitive to electrostatic discharges. Avoid touching this glass bulb at all times.

During operation, ESD wrist straps should be worn to avoid possible damage to the electrode by electrostatic discharges.

Any variation introduced by the user to the supplied equipment may degrade the instrument's EMC performance.

To avoid electrical shock, do not use this instrument when voltages at the measurement surface exceed 24VAC or 60VDC.

To avoid damages or burns, do not perform any measurement in microwave ovens.

WARRANTY

All Hanna Instruments meters are guaranteed for two years against defects in workmanship and materials when used for their intended purpose and maintained according to instructions. The electrodes and the probes are guaranteed for a period of six months. This warranty is limited to repair or replacement free of charge.

Damage due to accident, misuse, tampering or lack of prescribed maintenance are not covered.

If service is required, contact the dealer from whom you purchased the instrument. If under warranty, report the model number, date of purchase, serial number and the nature of the failure. If the repair is not covered by the warranty, you will be notified of the charges incurred. If the instrument is to be returned to Hanna Instruments, first obtain a Returned Goods Authorization number from the Customer Service department and then send it with shipping costs prepaid. When shipping any instrument, make sure it is properly packaged for complete protection.

To validate your warranty, fill out and return the enclosed warranty card within 14 days from the date of purchase.

All rights are reserved. Reproduction in whole or in part is prohibited without the written consent of the copyright owner, Hanna Instruments Inc., 584 Park East Drive, Woonsocket, Rhode Island, 02895, USA.

Hanna Instruments reserves the right to modify the design, construction and appearance of its products without advance notice.

PRELIMINARY EXAMINATION

Remove the instrument from the packing material and examine it carefully to make sure that no damage has occurred during shipping. If there is any damage, notify your Dealer or the nearest Hanna Customer Service Center.

Each meter comes supplied complete with:

- HI 1131B glass-body combination pH Electrode with 1 m (3.3') cable
- HI 7669/2W Temperature Probe
- HI 76404 Electrode Holder
- pH 4.01 & 7.01 Buffer Solutions (20mL each)
- HI 7071S Electrolyte Solution
- 12VDC Power Adapter
- Instruction Manual

Note: Save all packing material until you are sure that the instrument functions correctly. All defective item must be returned in the original packing with the supplied accessories.

GENERAL DESCRIPTION

The Hanna pH 210, pH 211, pH 212 and pH 213 are microprocessor-based bench meters for pH and temperature measurements.

pH 211 and pH 213 can also measure ion concentration (ISE) and ORP (Oxidation Reduction Potential) in the mV range.

The pH measurements are compensated for temperature effect manually or automatically with the HI 7669/2W temperature probe.

The meter comes equipped with a large easy-to-read LCD which shows the pH (or mV) and temperature simultaneously together with graphic symbols.

The calibration process is guided step by step through clear indications on the LCD. A stability indicator make the calibration procedure error-free.

Through the RS 232C serial port you can transfer the data to a PC (pH 212 and pH 213 only).

FUNCTIONAL DESCRIPTION pH 210 AND pH 211

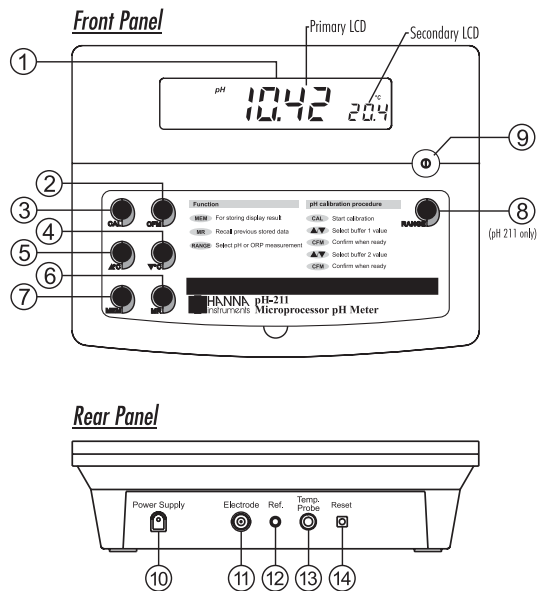

- 1) Liquid Crystal Display (LCD)
- 2) CFM key, to confirm calibration values
- 3) CAL key, to enter or exit calibration mode
- 4) ▼□ C key, to manually decrease temperature or select pH buffer
- 5) ▲□ C key, to manually increase temperature or select pH buffer
- 6) MR key, to recall the stored value
- 7) MEM key, to store a value in memory
- 8) RANGE key, to select measurement range (pH 211 only)
- 9) ON/OFF switch
- 10) Power adapter socket
- 11) BNC electrode connector
- 12) Electrode reference socket
- 13) Temperature probe socket
- 14) RESET button

Extension cables for screw-type electrodes (screw to BNC adapter)

HI 7855/1 Extension cable 1m (3.3') long

HI 7855/3 Extension cable 3m (9.9') long

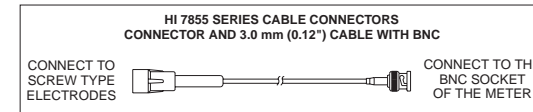

OTHER ACCESSORIES

HI 710005 Voltage adapter from 115 VAC to 12 VDC (USA plug)

HI 710006 Voltage adapter from 230 VAC to 12 VDC (European plug)

HI 710012 Voltage adapter from 240 VAC to 12 VDC (UK plug)

HI 710013 Voltage adapter from 230 VAC to 12 VDC (South Africa plug)

HI 710014 Voltage adapter from 230 VAC to 12 VDC (Australia plug)

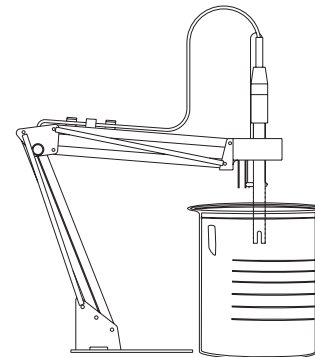

ChecktempC Pocket-size thermometer (range -50.0 to 150.0□ C)

HI 76405 Electrode holder

HI 8427 pH and ORP electrode simulator with 1 m (3.3') coaxial cable ending in female BNC connectors

HI 931001 pH and ORP electrode simulator with LCD and 1 m (3.3') coaxial cable ending in female BNC connectors

HI 7669/2W Temp. probe with 1 m (3.3') cable

HI 92000 Windows® compatible software

HI 920010 9 to 9-pin RS232 cable

Windows® is registered Trademark of "Microsoft Co."

HI 1413B

Glass-body, single junction, flat tip, Viscolene, non-refillable, combination pH electrode. Use: surface measurement.

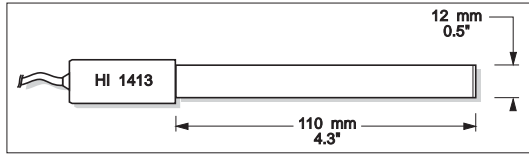

ORP ELECTRODES

HI 3131B

Glass-body, refillable, combination platinum ORP electrode. Use: titration.

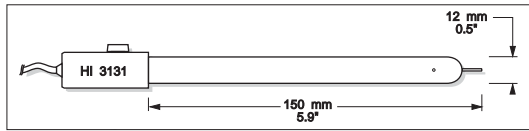

HI 3230B

Plastic-body (Ultem®), gel-filled, combination platinum ORP electrode. Use: general purpose.

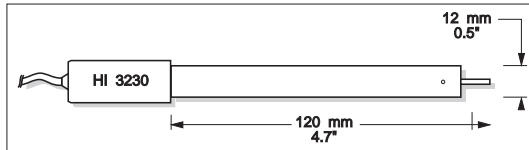

HI 4430B

Plastic-body (Ultem®), gel-filled, combination gold ORP electrode. Use: general purpose.

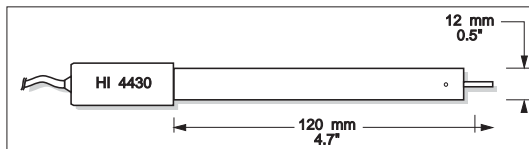

Consult the Hanna General Catalog for more electrodes with screw-type or BNC connectors.

Ultem® is registered Trademark of "General Electric Co."
Kynar® is registered Trademark of "Pennwalt Corp."

SPECIFICATIONS pH 210 AND pH 211

Range	pH	0.00 to 14.00
	mV	±399.9 (ISE, pH 211 only)
	mV	±1999 (ORP, pH 211 only)
	°C	0.0 to 100.0
Resolution	pH	0.01
	mV	0.1 (ISE, pH 211 only)
	mV	1 (ORP, pH 211 only)
	°C	0.1
Accuracy (@20°C/68°F)	pH	±0.01
	mV	±0.2 mV (ISE, pH 211 only)
	mV	±1mV (ORP, pH 211 only)
	°C	±0.5
Typical EMC Deviation	pH	±0.03
	mV	±2 mV (pH 211 only)
	°C	±0.3
pH Calibration		Automatic 1 or 2 points with 5 memorized buffers (4.01, 6.86, 7.01, 9.18, 10.01)
Temperature Compensation		Automatic or manual from 0 to 100°C (32 to 212°F)
Electrode		HI 1131B glass-body combination refillable pH electrode (included)
Temperature probe		HI 7669/2W (included)
Input impedance		10 ¹² Ω
Power supply		12 VDC adapter (included)
Environment		0 to 50°C (32 to 122°F) max. 95% RH non-condensing
Dimensions		240x182x74 mm (9.4x7.1x2.9")
Weight		1.1 kg (2.5 lb.); kit with holder: 2.5 kg (5.5 lb.)

FUNCTIONAL DESCRIPTION

pH 212 AND pH 213

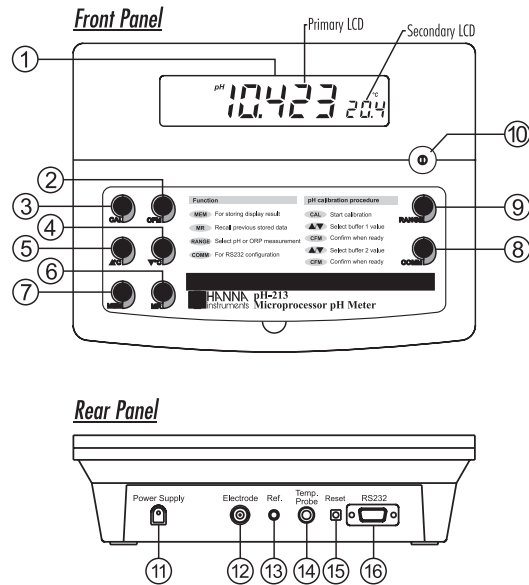

- 1) Liquid Crystal Display (LCD)
- 2) CFM key, to confirm calibration values
- 3) CAL key, to enter or exit calibration mode
- 4) ▼□ C key, to manually decrease temperature or select pH buffer
- 5) ▲□ C key, to manually increase temperature or select pH buffer
- 6) MR key, to recall the stored value
- 7) MEM key, to store a value in memory
- 8) COMM key, to set baud rate
- 9) RANGE key, to select measurement range
- 10) ON/OFF switch
- 11) Power adapter socket
- 12) BNC electrode connector
- 13) Electrode reference socket
- 14) Temperature probe socket
- 15) RESET button
- 16) RS232C socket

FC 100B

Plastic-body (Kynar®), double junction, refillable, combination pH electrode. Use: general purpose for food industry.

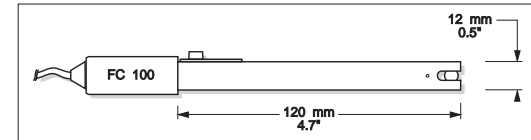

FC 200B

Plastic-body (Kynar®), open junction, conic, Viscolene, non-refillable, combination pH electrode. Use: meat & cheese.

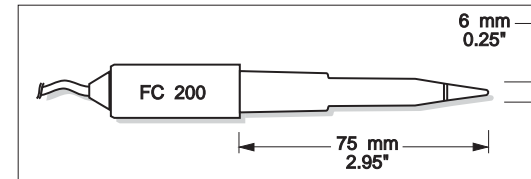

FC 210B

Glass-body, double junction, conic, Viscolene, non-refillable, combination pH electrode. Use: milk, yogurt.

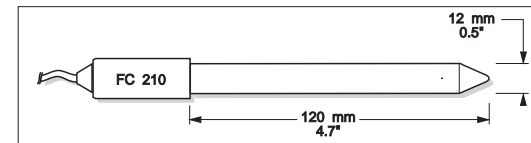

FC 220B

Glass-body, triple-ceramic, single junction, refillable, combination pH electrode. Use: food processing.

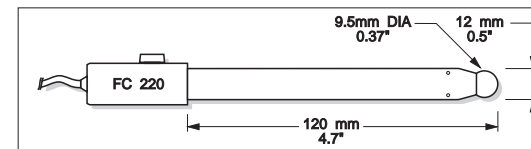

FC 911B

Plastic-body (Kynar®), double junction, refillable with built-in amplifier, combination pH electrode. Use: very high humidity.

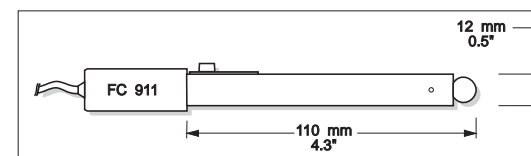

HI 1330B

Glass-body, semimicro, single junction, refillable, combination pH electrode. Use: laboratory, vials.

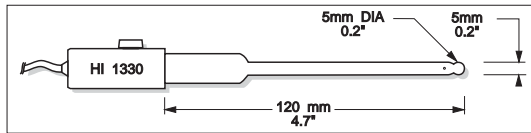

HI 1331B

Glass-body, semimicro, single junction, refillable, combination pH electrode. Use: flasks.

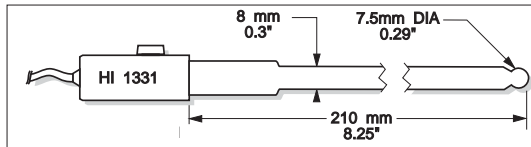

HI 1230B

Plastic-body (Ultem®), double junction, gel-filled, combination pH electrode. Use: general, field.

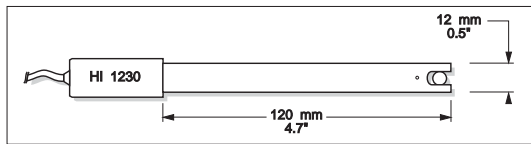

HI 2031B

Glass-body, semimicro, conic, refillable, combination pH electrode. Use: semisolid products.

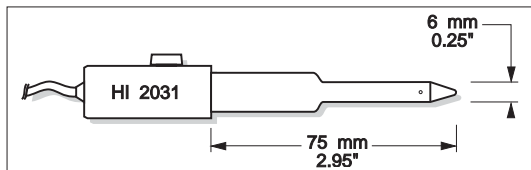

HI 1332B

Plastic-body (Ultem®), double junction, refillable, combination pH electrode. Use: general purpose.

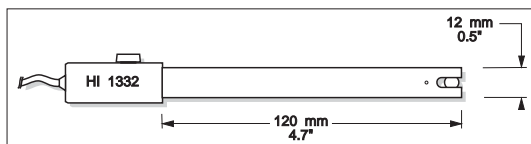

SPECIFICATIONS pH 212 AND pH 213

Range	pH mV °C	-2.00 to 16.00 / -2.000 to 16.000 ±999.9 (ISE and ORP, pH 213 only) 0.0 to 100.0
Resolution	pH mV °C	0.01 / 0.001 0.1 (ISE and ORP, pH 213 only) 0.1
Accuracy (@20°C/68°F)	pH mV °C	±0.002 & ±0.01 ±0.05% f.s. (ISE and ORP, pH 213 only) ±0.5
Typical EMC Deviation	pH mV °C	±0.01 ±0.6 (pH 213 only) ±0.5
pH Calibration		Automatic 1 or 2 points with 5 memorized buffers (4.01, 6.86, 7.01, 9.18, 10.01)
Temperature Compensation		From 0 to 100°C (32 to 212°F) manual or automatic with HI 7669/2W probe (included)
Electrode		HI 1131B glass-body combination refillable pH electrode (included)
Temperature probe		HI 7669/2W (included)
Input impedance		10 ¹² Ω
Computer Interface		Opto-isolated RS232C
Power supply		12 VDC adapter (included)
Environment		0 to 50°C (32 to 122°F) max. 95% RH non-condensing
Dimensions		240x182x74 mm (9.4x7.1x2.9")
Weight		1.1 kg (2.5 lb.); kit with holder: 3.0 kg (6.5 lb.)

OPERATIONAL GUIDE

Power connection

Plug the 12VDC adapter into the power supply socket (#10 on page 4; #11 on page 6).

Note: pH 212 and pH 213 use an EEPROM to retain the pH, mV and temperature calibrations as well as the serial communication setting. The instrument will retain the data after a calibration or serial communication setting, even when it is unplugged.

Note: Make sure the main line is protected by a fuse.

Electrode and Probe connections

For combination pH or ORP electrodes (with internal reference) connect the electrode's BNC to the socket on the back of the meter (#11 on page 4; #12 on page 6).

For electrodes with a separate reference, connect the single cell electrode's BNC to the BNC socket (#11 on page 4; #12 on page 6) and the reference electrode plug to the reference socket (#12 on page 4; #13 on page 6).

For temperature measurements and automatic temperature compensation connect the temperature probe to the appropriate socket (#13 on page 4; #14 on page 6).

Note: to prevent damage to the electrode, remove the pH electrode from the solution before turning the meter off.

If the meter is OFF, detach the electrode from the meter before immersing the electrode in the storage solution.

pH MEASUREMENTS

Make sure that the instrument has been calibrated before taking pH measurements.

Switch the instrument on by pressing the ON/OFF switch. The meter automatically defaults to the pH measurement mode.



Submerge the tip (4cm/1½") of the electrode and the temperature probe into the sample to be tested. Allow time for the electrode to stabilize.

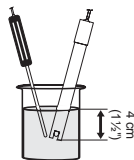

ORP PRETREATMENT SOLUTIONS

HI 7091L Reducing Pretreatment Solution, 460 mL

HI 7092L Oxidizing Pretreatment Solution, 460 mL

pH ELECTRODES

All electrodes part numbers ending in B are supplied with a BNC connector and 1 m (3.3') cable, as shown below :

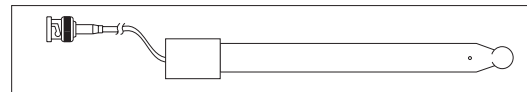

HI 1043B

Glass-body, double junction, refillable, combination pH electrode. Use: strong acid/alkali.

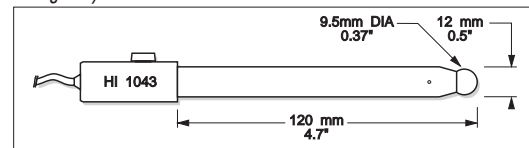

HI 1053B

Glass-body, triple ceramic, conic shape, refillable, combination pH electrode. Use: emulsions.

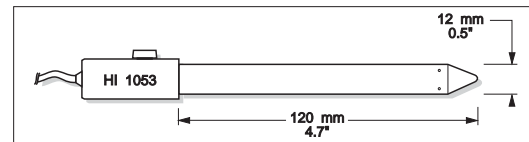

HI 1083B

Glass-body, micro, Viscolene, non-refillable, combination pH electrode. Use: biotechnology, micro titration.

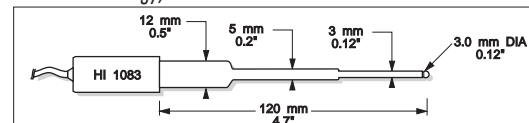

HI 1131B

Glass-body, single junction, refillable, combination pH electrode. Use: general purpose.

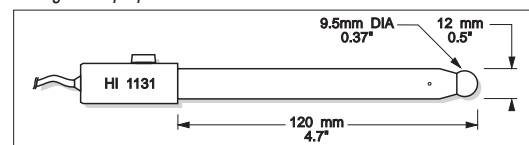

ACCESSORIES

pH CALIBRATION SOLUTIONS

HI 70004P	pH 4.01 Buffer Sachets, 20mL, 25 pcs
HI 70007P	pH 7.01 Buffer Sachets, 20mL, 25 pcs
HI 70010P	pH 10.01 Buffer Sachets, 20mL, 25 pcs
HI 7004L	pH 4.01 Buffer Solution, 460 mL
HI 7006L	pH 6.86 Buffer Solution, 460 mL
HI 7007L	pH 7.01 Buffer Solution, 460 mL
HI 7009L	pH 9.18 Buffer Solution, 460 mL
HI 7010L	pH 10.01 Buffer Sol., 460 mL
HI 8004L	pH 4.01 Buffer Solution in FDA approved bottle, 460 mL
HI 8006L	pH 6.86 Buffer Solution in FDA approved bottle, 460 mL
HI 8007L	pH 7.01 Buffer Solution in FDA approved bottle, 460 mL
HI 8009L	pH 9.18 Buffer Solution in FDA approved bottle, 460 mL
HI 8010L	pH 10.01 Buffer Solution in FDA approved bottle, 460 mL

ELECTRODE STORAGE SOLUTIONS

HI 70300L	Storage Solution, 460 mL
HI 80300L	Storage Solution in FDA approved bottle, 460 mL

ELECTRODE CLEANING SOLUTIONS

HI 70000P	Electrode Rinse Sachets, 20 mL, 25 pcs
HI 7061L	General Cleaning Sol., 460 mL
HI 7073L	Protein Cleaning Sol., 460mL
HI 7074L	Inorganic Cleaning Sol., 460mL
HI 7077L	Oil & Fat Cleaning Sol., 460 mL
HI 8061L	General Cleaning Solution in FDA approved bottle, 460 mL
HI 8073L	Protein Cleaning Solution in FDA approved bottle, 230 mL
HI 8077L	Oil & Fat Cleaning Solution in FDA approved bottle, 460mL

REFILL ELECTROLYTE SOLUTIONS

HI 7071	3.5M KCl + AgCl Electrolyte, 4x50mL, for single junction electrodes
HI 7072	1M KNO ₃ Electrolyte, 4x50 mL
HI 7082	3.5M KCl Electrolyte, 4x50 mL, for double junction electrodes
HI 8071	3.5M KCl + AgCl Electrolyte in FDA approved bottle, 4x50mL, for single junction electrodes
HI 8072	1M KNO ₃ Electrolyte in FDA approved bottle, 4x50 mL
HI 8082	3.5M KCl Electrolyte in FDA approved bottle, 4x50 mL, for double junction electrodes

- pH is displayed on the primary display and temperature on the secondary one.



- With pH 211 and pH 213 it is also possible to view the mV reading by pressing the "RANGE" key.

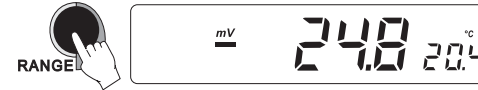

If measurements are taken successively in different samples, it is recommended to rinse the electrode thoroughly with deionized water or, if not available, tap water first and then with some of the next sample to condition the electrode before immersing it in the sample. The pH reading is affected by temperature. In order for the meter to measure the pH accurately, temperature must be taken into consideration. To use the Automatic Temperature Compensation feature, connect and submerge the HI 7669/2W temperature probe into the sample as close to the electrode as possible and wait for a couple of minutes.

If the temperature of the sample is known or tests are always performed at the same temperature you can simply manually compensate for it. For this purpose the temperature probe must be disconnected.

The display will then show the default temperature of 25°C or the last recorded temperature reading with the "°C" symbol blinking.

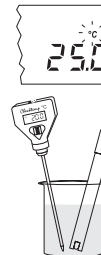

Note the temperature of the sample using a ChecktempC or an accurate reference thermometer.

The temperature can now be adjusted with the ▲°C and ▼°C keys.



ORP MEASUREMENTS (pH211 and pH213 only)

An optional ORP electrode must be used to perform ORP measurements (see accessories).

Oxidation-reduction potential (REDOX) measurements provide the quantification of the oxidizing or reducing power of the sample tested.

To correctly perform a redox measurement, the surface of the ORP electrode must be clean and smooth.

- Switch the meter on and press the "RANGE" key to enter the mV mode.



- Submerge the ORP electrode tip (4cm/1½") into the sample. Allow a few minutes for the reading to stabilize.

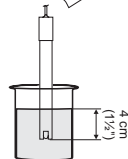

- The meter displays the mV reading on the primary display.

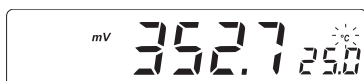

- If readings are out of range, "--" will appear on the LCD.



TAKING TEMPERATURE MEASUREMENTS

Taking a temperature measurement is very easy. Connect the HI 7669/2W temperature probe and turn the instrument on. Dip the temperature probe in the sample and allow the reading on the secondary display to stabilize.



HOLD FUNCTION

Press and hold MEM. The last reading will be frozen on the display until MEM is released. During this operation, the MEM indicator is also shown on the LCD.



Press MR and the previously memorized reading will be displayed with the MEM indicator on the LCD.



TROUBLESHOOTING GUIDE

Symptoms	Problem	Solution
The meter is slow in responding or gives faulty readings	The electrode is not working or the reference junction is clogged	Leave the electrode in a storage solution after cleaning the junction. If problem persists, replace the electrode
The meter does not accept the 2 nd buffer solution for calibration	Out of order pH electrode	Follow the cleaning procedure. If this doesn't work replace the electrode
The reading drifts	Defective pH electrode	Replace the electrode
Display shows: 	Out of range pH scale	a) Recalibrate b) Make sure the pH sample is in the specified range c) Check the electrolyte level and the general state of the pH electrode
Display shows: 	Out of range temperature scale	Make sure the temperature is in the 0 to 100 °C range and the temperature probe is plugged in
Display shows: 	Out of range mV scale	Electrode not connected
Display shows: "WRONG 1" and "WRONG 2"	Erroneous buffer solution used for offset calibration	Make sure the buffer setting is correct and the solution is fresh. Replace the buffer if necessary
	Defective electrode	Replace the electrode
Display shows: "WRONG 2" and "WRONG 1"	Erroneous buffer solution used for slope calibration	Make sure the buffer setting is correct and the solution is fresh. Replace the buffer if necessary
	Defective electrode	Replace the electrode
The meter does not work with the temperature probe	Out of order temperature probe	Replace the probe
The meter fails to calibrate or gives faulty readings	Out of order pH electrode	Replace the electrode

TEMPERATURE CORRELATION FOR pH SENSITIVE GLASS

The resistance of glass electrodes partially depends on the temperature. The lower the temperature, the higher the resistance. It takes longer time for the reading to stabilize if the resistance is higher. In addition, the response time will suffer to a greater degree at temperatures below 10 °C.

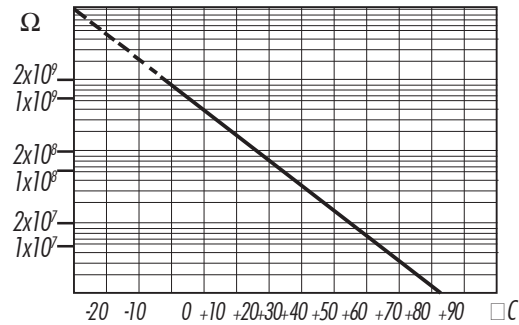

Since the resistance of the pH electrode is in the range of 200 Mohm, the current across the membrane is in the pico Ampere range. Large currents can disturb the calibration of the electrode for many hours.

For these reasons high humidity environments, short circuits and static discharges are detrimental to a stable pH reading.

The pH electrode's life also depends on the temperature. If constantly used at high temperatures, the electrode life is drastically reduced.

Typical Electrode Life	
Ambient Temperature	1- 3 years
90 °C	Less than 4 months
120°C	Less than 1 month

High concentrations of sodium ions interfere with readings in alkaline solutions; the pH at which the interference starts to be significant depends upon the composition of the glass. This interference is the alkaline error and causes the pH to be underestimated. Hanna's glass formulations have the indicated characteristics.

Alkaline Error

Sodium Ion Correction for the Glass at 20-25°C		
Concentration	pH	Error
0.1 Mol L ⁻¹ Na ⁺	13.00	0.10
	13.50	0.14
	14.00	0.20
1.0 Mol L ⁻¹ Na ⁺	12.50	0.10
	13.00	0.18
	13.50	0.29
	14.00	0.40

RESET

The RESET button (#14 on page 4, #15 on page 6) should only be used when the instrument displays erroneous messages due to strong electrical interference or when the instrument's power supply was disconnected before the meter was switched off.

After pressing RESET always recalibrate the unit before proceeding.

pH CALIBRATION

Calibrate the instrument often, especially if high accuracy is required.

The instrument should be recalibrated :

- Whenever the pH electrode is replaced.
- At least once a week.
- After testing aggressive chemicals.
- After pressing RESET.
- If higher accuracy is required.

PREPARATION

Pour small quantities of the buffer solutions into clean beakers. If possible use plastic beakers to minimize any EMC interferences.

For accurate calibration and to minimize cross contamination, use two

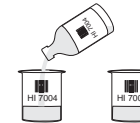

beakers for each buffer solution. One for rinsing the electrode and the second for calibration.



If you are measuring in the acid range, use pH 4.01 as second buffer; if you are measuring in the alkaline range, use pH 10.01 or pH 9.18 as second buffer.

PROCEDURE

Calibration has a choice of 5 memorized buffers: pH 4.01, 6.86, 7.01, 9.18 and 10.01.

It is always recommended to perform a two-point calibration. The pH meters however also provide for one-point calibration, as described below.

One-point calibration

- Immerse the pH electrode and the temperature probe approximately 4 cm (1½") into a buffer solution of your choice (pH 4.01, 6.86, 7.01, 9.18 or 10.01) and stir gently. The temperature probe should be close to the pH electrode.

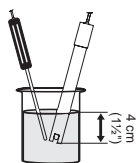

- Press CAL. The "CAL" and "BUF¹" indicators and the most common "7.01" buffer will be displayed on the secondary LCD.



- If necessary, press "▲□C" or "▼□C" to select a different buffer value.



- The "NOT READY" indication will blink on LCD until the reading has stabilized.



- When the reading is stable, "READY" and "CFM" will blink. Press CFM to confirm the calibration.



- If the reading is close to the selected buffer, the meter stores the reading. The calibrated value is then displayed on the primary LCD and the secondary LCD will display the second expected buffer value.



- If the value measured by the meter is not close to the selected buffer, "WRONG^{BUF}" and "WRONG ↓" will blink alternately. In this case check if the correct buffer has been used or refresh the electrode by following the maintenance procedure below. If necessary change the buffer or the electrode.

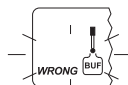

- Press CAL to quit calibration. The meter will return to normal operation and memorize the one-point calibration data.



CLEANING PROCEDURE

General Soak in Hanna HI 7061 or HI 8061 General Cleaning Solution for approximately ½ hour.

Removal of films, dirt or deposits on the membrane/junction:

- **Protein** Soak in Hanna HI 7073 or HI 8073 Protein Cleaning Solution for 15 minutes.
- **Inorganic** Soak in Hanna HI 7074 or HI 8074 Inorganic Cleaning Solution for 15 minutes.
- **Oil/grease** Rinse with Hanna HI 7077 or HI 8077 Oil and Fat Cleaning Solution.

IMPORTANT: After performing any of the cleaning procedures rinse the electrode thoroughly with distilled water, refill the reference chamber with fresh electrolyte (not necessary for gel-filled electrodes) and soak the electrode in HI 70300 or HI 80300 Storage Solution for at least 1 hour before taking measurements.

TROUBLESHOOTING

Evaluate your electrode performance based on the following.

- **Noise** (Readings fluctuate up and down) could be due to:
 - **Clogged/Dirty Junction:** Refer to the Cleaning Procedure above.
 - **Loss of shielding** due to low electrolyte level (in refillable electrodes only): refill with fresh HI 7071 or HI 8071 for single junction or HI 7082 or HI 8082 for double junction electrodes.
- **Dry Membrane/Junction:** Soak in HI 70300 or HI 80300 Storage Solution for at least 1 hour.
- **Drifting:** Soak the electrode tip in warm (approx. 50-60°C) Hanna HI 7082 or HI 8082 Solutions for one hour and rinse the tip with distilled water. Refill with fresh HI 7071 or HI 8071 for single junction electrodes and HI 7082 or HI 8082 for double junction electrodes (refillable electrodes only).
- **Low Slope:** Refer to the cleaning procedure above.
- **No Slope:** Check the electrode for cracks in glass stem or bulb and replace the electrode.
- **Slow Response/Excessive Drift:** Soak the tip in HI 7061 or HI 8061 Solutions for 30 minutes, rinse thoroughly in distilled water and then follow the Cleaning Procedure above.

For refillable electrodes:

If the filling solution (electrolyte) is more than 2½ cm (1") below the fill hole, add HI 7082 or HI 8082 3.5M KCl Electrolyte Solution for double junction or HI 7071 or HI 8071 3.5M KCl+AgCl Electrolyte Solution for single junction electrodes.

For a faster response, unscrew the fill hole screw during measurements.

For AmpHel® electrodes:

If the electrode does not respond to pH changes, the battery is run down and the electrode should be replaced.

MEASUREMENT

Rinse the electrode tip with distilled water. Immerse the tip (bottom 4 cm / 1½") in the sample and stir gently for a few seconds.

For a faster response and to avoid cross contamination of the samples, rinse the electrode tip with a few drops of the solution to be tested, before taking measurements.

STORAGE

To minimize clogging and assure a quick response time, the glass bulb and the junction should be kept moist and not allowed to dry out.

Replace the solution in the protective cap with a few drops of HI 70300 or HI 80300 Storage Solution or, in its absence, Filling Solution (HI 7071 or HI 8071 for single junction or HI 7082 or HI 8082 for double junction electrodes). Follow the Preparation Procedure above before taking measurements.

Note: NEVER STORE THE ELECTRODE IN DISTILLED OR DEIONIZED WATER.

PERIODIC MAINTENANCE

Inspect the electrode and the cable. The cable used for connection to the meter must be intact and there must be no points of broken insulation on the cable or cracks on the electrode stem or bulb. Connectors must be perfectly clean and dry. If any scratches or cracks are present, replace the electrode. Rinse off any salt deposits with water.

For refillable electrodes:

Refill the reference chamber with fresh electrolyte (HI 7071 or HI 8071 for single junction or HI 7082 or HI 8082 for double junction electrodes). Allow the electrode to stand upright for 1 hour.

Follow the Storage Procedure above.

AmpHel® is a registered Trademark of "Hanna Instruments"

Two-point calibration

Any two of the 5 memorized buffers can be used for this purpose. However, it is recommended that pH 6.86 or 7.01 is chosen as the first point and pH 4.01 (acidic) or pH 9.18/10.01 (alkaline) as the second point.

• Proceed as described in "One-point calibration" above but do not quit calibration by pressing CAL at the end.

• After the first calibration point is confirmed, immerse the pH electrode and the temperature probe approximately 4 cm (1½") in the second buffer solution and stir gently. The temperature probe should be close to the pH electrode.

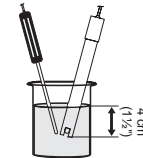

• If necessary, press "▲□C" or "▼□C" to select a different buffer value.



Note: The meter will automatically skip the buffer used for the first point. It also skips 6.86 if 7.01 was used, and viceversa. Likewise, it will skip 9.18 if 10.01 was used, and viceversa.

• The "NOT READY" indication will blink on LCD until the reading has stabilized.



• When the reading is stable, "READY" and "CFM" will blink. Press CFM to confirm the calibration.



• If the reading is close to the selected buffer, the meter stores the reading and returns to normal operational mode.

• If the value measured by the meter is not close to the selected buffer, "WRONG ^{buf}" and "WRONG !" will blink alternately. In this case check if the correct buffer has been used, or regenerate the electrode by following the cleaning procedure below. If necessary change the buffer or the electrode.

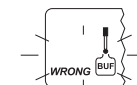

Note: Press RANGE to display the temperature reading on the LCD during calibration (pH211, pH212, pH213 only).



TEMPERATURE CALIBRATION pH 212 AND pH 213 ONLY (for technical personnel only)

All the meters are factory calibrated for temperature.

The temperature probes are interchangeable and no temperature calibration is needed when they are replaced.

If, for any reason, the temperature measurements are inaccurate, temperature recalibration may be carried out.

For an accurate recalibration, contact your dealer or the nearest Hanna Customer Service Center.

- Prepare a vessel containing ice and water and another one containing hot water (at a temperature of around 50°C). Place insulation material around the vessels to minimize temperature changes.

- Use a ChecktempC or a calibrated thermometer with a resolution of 0.1°C as a reference thermometer.

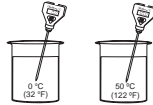

- With the instrument off, press and hold CAL and then the ON switch. The "CAL" indicator will come on and the secondary LCD will show 0.0°C.

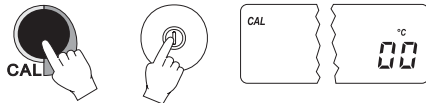

- Immerse the temperature probe in the vessel with the ice and water as near to the ChecktempC as possible. Allow a couple of minutes for the probe to stabilize.



- Use the "▲°C" or "▼°C" key to set the reading on the secondary LCD to that of ice and water, measured by checktempC (for example, 0.1°C).

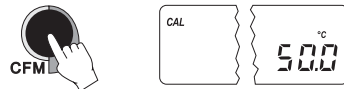

- Press CFM to confirm. The secondary LCD will show 50.0°C.
- Immerse the temperature probe in the second vessel as near to the ChecktempC as possible.



ELECTRODE CONDITIONING & MAINTENANCE

Note: To prevent damage to the electrode, remove the pH electrode from the solution before turning the meter off.

If the meter is OFF, detach the electrode from the meter before immersing the electrode in the storage solution.

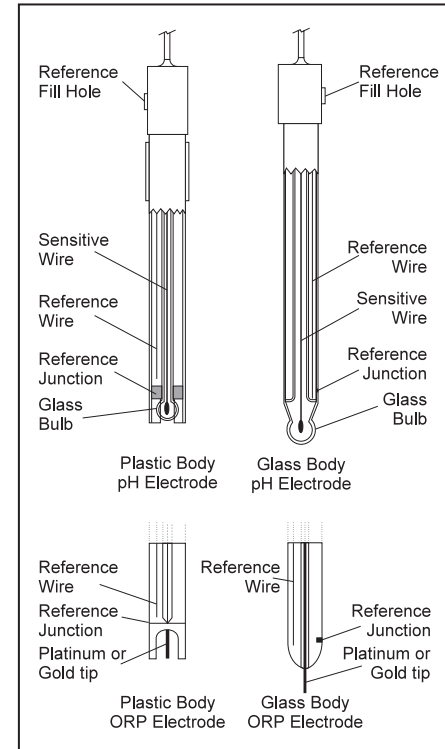

PREPARATION

Remove the protective cap.

DO NOT BE ALARMED IF SALT DEPOSITS ARE PRESENT. This is normal with electrodes and they will disappear when rinsed with water.

During transport tiny bubbles of air may form inside the glass bulb affecting proper functioning of the electrode. These bubbles can be removed by "shaking down" the electrode as you would do with a glass thermometer.

If the bulb and/or junction is dry, soak the electrode in HI 70300 or HI 80300 Storage Solution for at least one hour.

pH VALUES AT VARIOUS TEMPERATURES

Temperature has an effect on pH. The calibration buffer solutions are affected by temperature changes to a lesser degree than normal solutions. During calibration the meter will automatically calibrate to the pH value corresponding to the measured or set temperature.

TEMP		pH VALUES				
°C	°F	4.01	6.86	7.01	9.18	10.01
0	32	4.01	6.98	7.13	9.46	10.32
5	41	4.00	6.95	7.10	9.39	10.24
10	50	4.00	6.92	7.07	9.33	10.18
15	59	4.00	6.90	7.04	9.27	10.12
20	68	4.00	6.88	7.03	9.22	10.06
25	77	4.01	6.86	7.01	9.18	10.01
30	86	4.02	6.85	7.00	9.14	9.96
35	95	4.03	6.84	6.99	9.10	9.92
40	104	4.04	6.84	6.98	9.07	9.88
45	113	4.05	6.83	6.98	9.04	9.85
50	122	4.06	6.83	6.98	9.01	9.82
55	131	4.07	6.84	6.98	8.99	9.79
60	140	4.09	6.84	6.98	8.97	9.77
65	149	4.11	6.85	6.99	8.95	9.76
70	158	4.12	6.85	6.99	8.93	9.75

For instance, if the buffer temperature is 25°C, the display will show pH 4.01 or 7.01 or 10.01. If the buffer temperature is 20°C, it will show pH 4.00/7.03/10.06 or at 50°C, the display will show pH 4.06/6.98/9.82.

Allow a couple of minutes for the probe to stabilize.

- Use the "▲□C" or "▼□C" key to set the reading on the secondary LCD to that of the hot water
- Press CFM to confirm. The meter returns to normal operational mode.

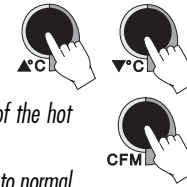

mV CALIBRATION pH 213 ONLY (for technical personnel only)

All the meters are factory calibrated for mV.

The ORP electrodes are interchangeable and no mV calibration is needed when they are replaced.

If, for any reason, the mV measurements are inaccurate, mV recalibration may be carried out.

For an accurate recalibration, contact your dealer or the nearest Hanna Customer Service Center.

- Attach to the electrode BNC connector a mV simulator with a range of at least ± 500.0 mV and an accuracy of ± 0.1 mV.
- With the instrument off, press and hold CFM and then the ON switch. The "CAL" indicator will come on and the primary LCD will show 380.0 mV.
- Set 380.0 mV on the simulator.

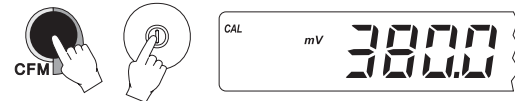

- Wait for 3 sec. and press CFM. The LCD will display -380.0 mV asking for this value to be set.
- Set -380.0 mV on the simulator.
- Wait for 3 sec. and press CFM. The LCD will display 500.0 mV.
- Set 500.0 mV on the simulator.
- Wait for 3 sec. and press CFM. The LCD will display -500.0 mV.
- Set -500.0 mV on the simulator.
- Wait for 3 sec. and press CFM.
- The secondary LCD will display 0.0°C. It is now possible to proceed with the temperature calibration, if necessary, as described above, or return to normal operation by pressing CAL.



INTERFACE WITH PC (pH 212 AND pH 213 ONLY)

Data transmission from the instrument to the PC is now much easier with the new HI 92000 Windows® compatible application software (optional). HI 92000 also offers an on-line help feature.

Simply run your desired spread sheet and open the file downloaded by HI 92000. Data can be further elaborated with graphics, statistical analysis, etc. using the most diffused spread sheet programs (e.g. Excel®, Lotus 1-2-3®).

To install HI 92000 you need a 3.5" drive and a few minutes to follow the instructions printed on the disk label.

To connect your meter to the PC use the optional Hanna HI 920010 cable connector. Make sure that your meter is switched off and plug the connectors, one into the meter RS232C socket and the other into the serial port of your PC.

Note: Cables other than HI 920010 may use a different configuration, in which case, communication between the meter and the PC may not be possible.

If you are not using Hanna Instruments HI 92000 application software, please find below some additional information to help you link-up to your PC.

Setting the Baud Rate and the Command Prefix

The baud rate of the meter and of the external device must be the same. To set the baud rate of the meter press COMM, the primary LCD shows the current baud rate.



The following baud rates can be selected with the "▲□C" or "▼□C" key: 150, 300, 600, 1200 (factory setting) and 2400.

Press CFM to confirm the setting. The primary LCD will show the current command prefix (factory setting is 16).

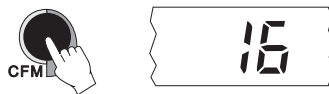

Note: The Command Prefix must not be changed when using Hanna HI 92000 Software.

Excel® Copyright of "Microsoft Co."
Lotus 1-2-3® Copyright of "Lotus Co."
Windows® is registered Trademark of "Microsoft Co."

Select, if necessary, a different command prefix (between 0 and 47) by pressing the "▲□C" or "▼□C" key.



Press CFM to confirm the setting.



Sending Commands from PC

With any terminal program it is possible to remotely control your meter. Use HI 920010 cable to connect the meter to a PC, start the terminal program and set the communication options as follows: 8, N, 1, no flow control.

Command Types

To send a command to the pH meter the scheme is:

<DLE> <command> <CR>

This line makes the computer send a Data Link Escape character, the command expressed as a 3-character sequence and a CR character.

Note: All the terminal programs that support the ANSI escape sequence, represent the DLE character by the string '^P' and the CR character by the string '^M'.

Commands not requiring an answer from the pH meter:

- PHR sets the range to pH
- MVR sets the range to mV (pH 213 only)
- CAL is equivalent to pressing the CAL key
- CFM is equivalent to pressing the CFM key
- UPC is equivalent to pressing the ▲□C key
- DWC is equivalent to pressing the ▼□C key
- MEM is equivalent to pressing the MEM key
- MRR is equivalent to pressing the MR key
- COM is equivalent to pressing the COMM key
- OFF sets the meter in standby mode

Commands requiring an answer:

- pH? Causes the meter to send the pH reading ("Err 1" is sent if out of range). If the range is set to mV, "Err 6" is sent.
- mV? Causes the meter to send the mV reading ("Err 2" is sent if out of range). If the range is set to pH, "Err 6" is sent.
- TM? Causes the meter to send the temperature reading ("Err 3" is sent if out of range).

These commands may be sent with either capital or small letters. Invalid commands will be ignored. The characters sent by the meter are always capital letters. When the meter receives an unknown or a corrupted command, it will send a character CAN (ASCII Code 24).